

32" x 24" MOTOR OPERATED WALL LOUVER (230V)

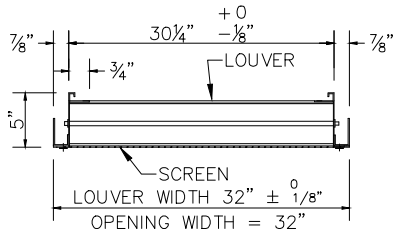

SECTION THRU LOUVER
(TOP VIEW)

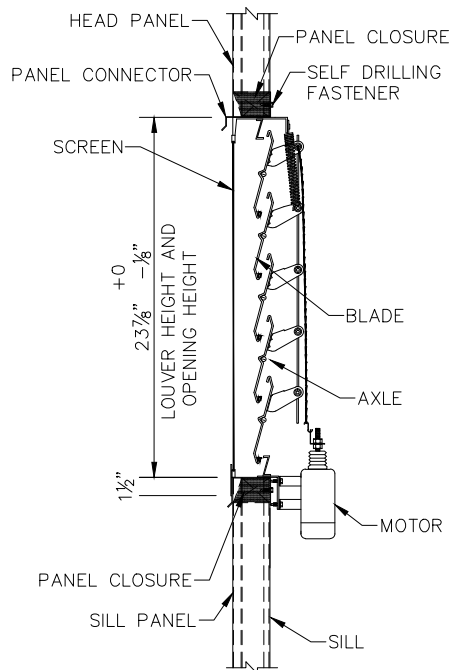
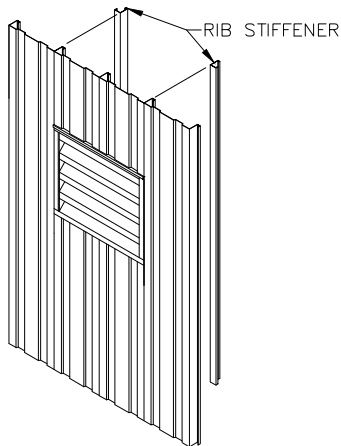

SECTION THRU LOUVER
(SIDE VIEW)

PRODUCT DESCRIPTION

MOTOR OPERATED LOUVER

32" wide x 24" high
(406 Sq. In. free area)

32" x 24" adjustable louvers shall be of self framing design. The louver frame shall be of nominal 14 gauge formed aluminum and the louver blades shall be of nominal 12 gauge extruded aluminum. Finish shall be natural mill finish and shall not require field painting.

Blades shall be pivoted on 1/2" diameter aluminum pivot pins through nylon flanged bearings and operated by means of a pull bar operating handle connected to a motor operator. All louvers shall be complete with an 18-14 aluminum mesh insect screen.

Motor operator is 230V, 60HZ .15 AMPS and designed for use with single panel wall louver. Unit opens and closes wall louver when fan motor is activated. The motor operator is equipped with a single phase motor, motor plate, linkage and mounting hardware.

- NOTES** - 1. Specify louver sill height.
Minimum sill or head height is 6".
2. Refer to Floor Plan and Elevation Drawing for exact size and location of accessories.