

SECTION THRU LOUVER
(TOP VIEW)

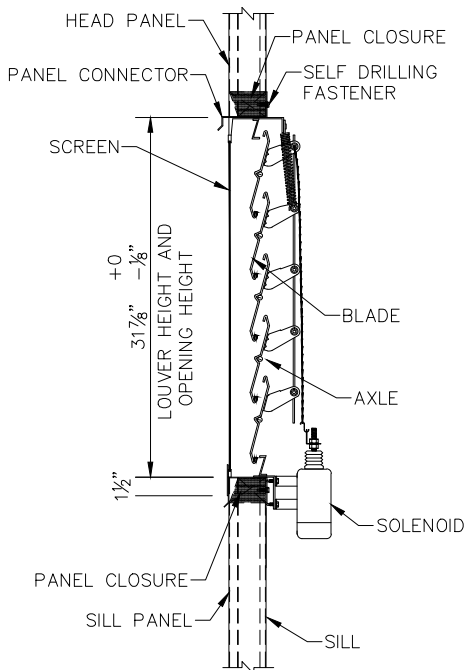
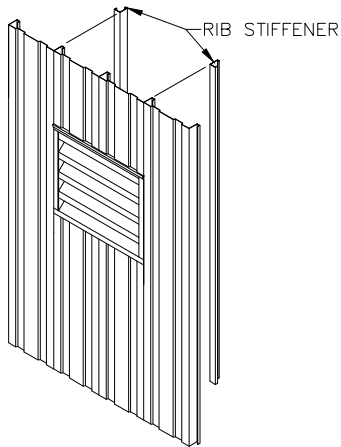

SECTION THRU LOUVER
(SIDE VIEW)

**32" x 32" SOLENOID
WALL LOUVER OPERATED**
(12 volt DC)

PRODUCT DESCRIPTION

SOLENOID OPERATED LOUVER
32" wide x 32" high
(543 Sq. In. free area)

32" x 32" adjustable louvers shall be of self framing design. The louver frame shall be of nominal 14 gauge formed aluminum and the louver blades shall be of nominal 12 gauge extruded aluminum. Finish shall be natural mill finish and shall not require field painting.

Blades shall be pivoted on 1/2" diameter aluminum pivot pins through nylon flanged bearings and operated by means of a pull bar operating handle connected to solenoid. All louvers shall be complete with an 18-14 aluminum mesh insect screen.

Solenoid operator is 12 VOLT DC, pole current 42 AMPS, hold current .6 AMPS and designed for use with single panel wall louver. Unit opens and closes wall louver when fan motor is activated. The solenoid operator is equipped with a single phase motor, motor plate, linkage and mounting hardware.

- NOTES:**
1. - Refer to Floor Plan and Elevation Drawing for exact size and location of accessories.
 2. - Specify louver sill height. Minimum sill or head height is 6"