

4'-0" ROOF VENTILATOR

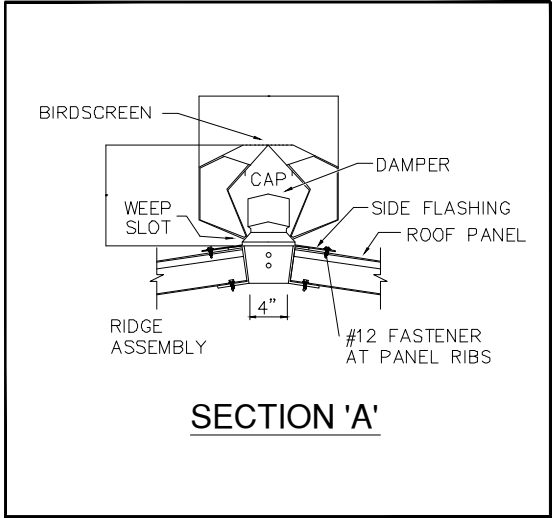

PRODUCT DESCRIPTION

RIDGE VENTILATOR (GABLE BUILDINGS ONLY)

4" THROAT x 4'-0" LONG

Ridge ventilator shall be 4'-0" long of gravity type with 4" throat and chain operated vertical lift dampers. Ventilators shall be made of nominal 26 gauge steel, factory painted white on all visible exterior galvanized surfaces. Top of ventilator shall have a bird screen cover.

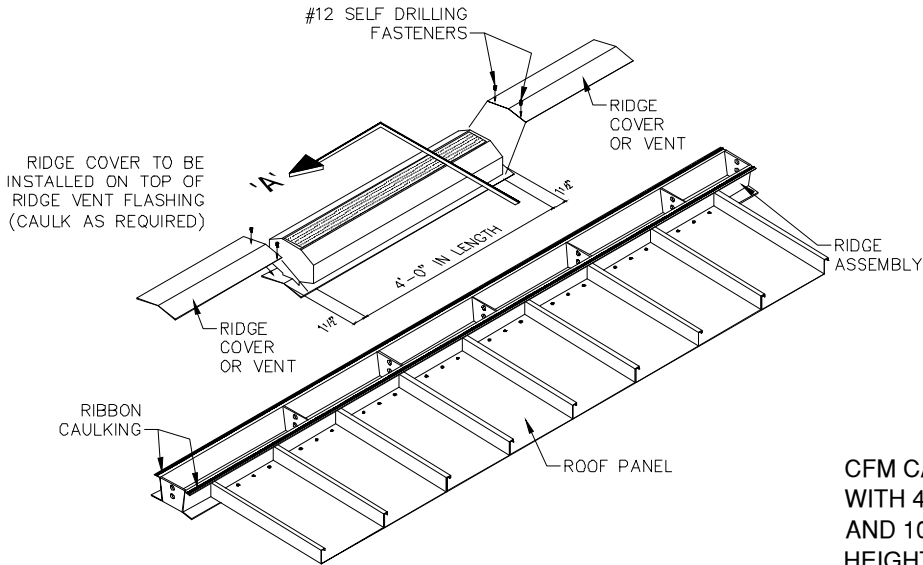

RIDGE VENTILATOR INSTALLATION

CFM CAPACITIES
WITH 4 MPH WIND
AND 10' BUILDING
HEIGHT.

EXHAUST CAPACITY (CFM)	
TEMP. DIFF. °F	4" THROAT x 4'-0"
10°	370
20°	430
30°	470

NOTE: Refer to Roof Plan and Elevation Drawing for exact size and location of accessories.



A - RV-4