

6'-8" WIDE WALL OPENING

PRODUCT DESCRIPTION

6'-8" WIDE WALL OPENING

All necessary framing and connectors to structurally replace the panels removed by wall opening. All trim and flashing required to make a unit placed in the opening weathertight, shall be provided by the supplier of the unit being installed.

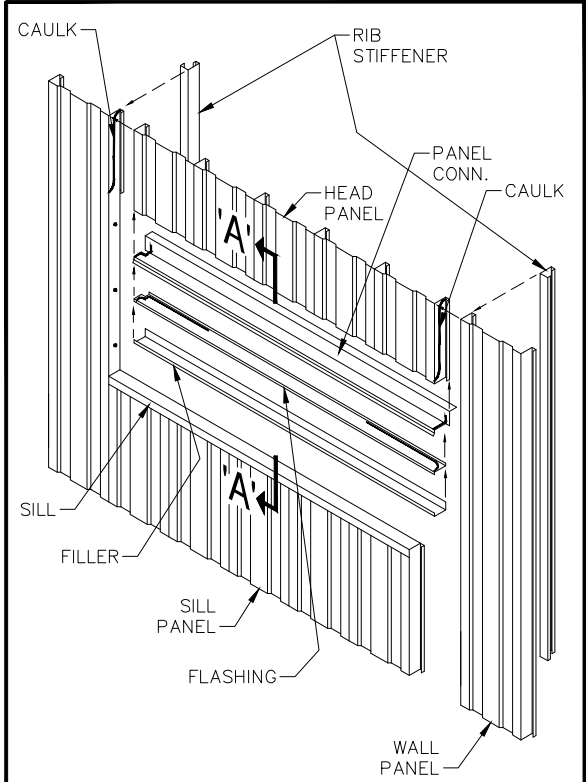

EXTERIOR ELEVATION

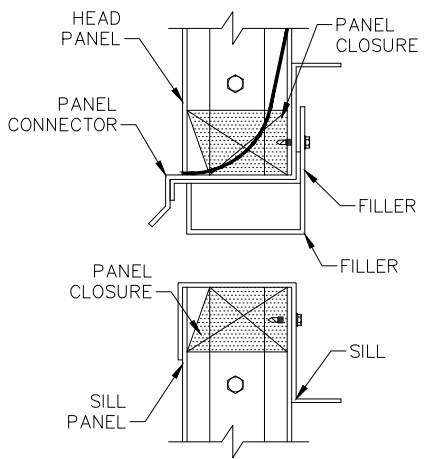

SECTION - 'A'-'A'

NOTES:

1. - Refer to Floor Plan and Elevation Drawing for exact size and location of accessories.
2. - Wall opening kits for customer supplied accessories must be field located, cut and flashed, unless prior arrangements are made with Parkline.
3. - For factory cutting of these openings, the exact location and finished opening sizes must be provided to Parkline.